



Industrial DC/DC CONVERTER MGDI-20 Wide Input : 20W POWER

Industrial Grade ■

3:1 & 4:1 Wide Input Single, Bi & Triple Outputs Metallic Case - 1 500 VDC Isolation

- Wide input range and high transient compliance
- Nominal power of 20 W without derating
- Wide temperature range : -40°C/+95°C case
- Soft start
- Permanent short circuit protection
- No optocoupler for high reliability
- RoHS process



1-General

The MGDI-20 wide input series is a full family of DC/DC power modules designed for use in distributed power architecture where variable input voltage and transient are prevalent making them ideal particularly for transportation, railways or high-end industrial applications. These modules use a high frequency fixed switching technic at 480 KHz providing excellent reliability, low noise characteristics, high power density and low profile package. Standard models are available with wide input voltage range of 4,7-16, 9-36, 16-40 and 36-140 volts, with high transient levels. The series include single and bi output voltage choices of 3,3, 5, 12, 15, +/-5, +/-12 or +/-15 volts.

No external heatsink is required for the MGDI-20 series to supply 20W output power over the case temperature range of -40°C up to 95°C. The MGDI-20 series is designed in conformity with safety standards EN60950 and UL1950.

All the modules are designed with LC network filters to minimize reflected input current ripple and output voltage ripple according to EN55022 and FCC Part 15J standard.

The modules include a soft-start, an input undervoltage lock-out, a permanent short circuit protection and an output overvoltage protection to ensure efficient module protections. The soft-start allows current limitation and eliminates inrush current during start-up. The short circuit protection completely protects the modules against short-circuits of any duration by a shut-down and restores to normal when the overload is removed.

The design has been carried out with surface mount components and is manufactured in a fully automated process to guarantee high quality. Each module is tested with a GAIA Converter automated test equipment.

5

2-Product Selection

Single output model : MGDSI - 20 - - /
 Bi output model : MGDBI - 20 - - /
 Triple output model : MGDTI - 20 - - /

Input Voltage Range

	Permanent	Transient
D :	4,7-16 VDC	n/a
H :	9-36 VDC	40 VDC/100 ms
J :	16-40 VDC*	45 VDC/100 ms
Q :	36-140 VDC**	175 VDC/100 ms

* for 45 Vdc consult factory
 ** for 154 Vdc consult factory

Options :

/M : option for On/Off function

Output

B : 3.3 VDC
 C : 5 VDC or +/-5VDC
 E : 12 VDC or +/-12VDC
 F : 15 VDC or +/-15VDC
 BE : 3.3 VDC and +/-12 VDC
 BF : 3.3 VDC and +/-15 VDC
 CE : 5 VDC and +/-12 VDC
 CF : 5 VDC and +/-15 VDC

2- Product Selection (continued)

Input range	Output	Current	Reference	Options
4,7-16 VDC	3,3 VDC	4 A	MGDSI-20-D-B	/M
4,7-16 VDC	5 VDC	4 A	MGDSI-20-D-C	/M
4,7-16 VDC	12 VDC	1,6 A	MGDSI-20-D-E	/M
4,7-16 VDC	15 VDC	1,3 A	MGDSI-20-D-F	/M
9-36 VDC	3,3 VDC	4 A	MGDSI-20-H-B	/M
9-36 VDC	5 VDC	4 A	MGDSI-20-H-C	/M
9-36 VDC	12 VDC	1,6 A	MGDSI-20-H-E	/M
9-36 VDC	15 VDC	1,3 A	MGDSI-20-H-F	/M
9-36 VDC	+/- 5 VDC	+/- 2 A	MGDBI-20-H-C	/M
9-36 VDC	+/- 12 VDC	+/- 0,80 A	MGDBI-20-H-E	/M
9-36 VDC	+/- 15 VDC	+/- 0,65 A	MGDBI-20-H-F	/M
9-36 VDC	3,3 & +/- 12 VDC	2 A & +/- 0,4 A	MGDTI-20-H-BE	/M
9-36 VDC	3,3 & +/- 15 VDC	2 A & +/- 0,3 A	MGDTI-20-H-BF	/M
9-36 VDC	5 & +/- 12 VDC	2 A & +/- 0,4 A	MGDTI-20-H-CE	/M
9-36 VDC	5 & +/- 15 VDC	2 A & +/- 0,3 A	MGDTI-20-H-CF	/M
16-40 VDC	3,3 VDC	4 A	MGDSI-20-J-B	/M
16-40 VDC	5 VDC	4 A	MGDSI-20-J-C	/M
16-40 VDC	12 VDC	1,6 A	MGDSI-20-J-E	/M
16-40 VDC	15 VDC	1,3 A	MGDSI-20-J-F	/M
16-40 VDC	+/- 5 VDC	+/- 2 A	MGDBI-20-J-C	/M
16-40 VDC	+/- 12 VDC	+/- 0,80 A	MGDBI-20-J-E	/M
16-40 VDC	+/- 15 VDC	+/- 0,65 A	MGDBI-20-J-F	/M
16-40 VDC	3,3 & +/- 12 VDC	2 A & +/- 0,4 A	MGDTI-20-J-BE	/M
16-40 VDC	3,3 & +/- 15 VDC	2 A & +/- 0,3 A	MGDTI-20-J-BF	/M
16-40 VDC	5 & +/- 12 VDC	2 A & +/- 0,4 A	MGDTI-20-J-CE	/M
16-40 VDC	5 & +/- 15 VDC	2 A & +/- 0,3 A	MGDTI-20-J-CF	/M
36-140 VDC	3,3 VDC	4 A	MGDSI-20-Q-B	/M
36-140 VDC	5 VDC	4 A	MGDSI-20-Q-C	/M
36-140 VDC	12 VDC	1,6 A	MGDSI-20-Q-E	/M
36-140 VDC	15 VDC	1,3 A	MGDSI-20-Q-F	/M
36-140 VDC	+/- 5 VDC	+/- 2 A	MGDBI-20-Q-C	/M
36-140 VDC	+/- 12 VDC	+/- 0,80 A	MGDBI-20-Q-E	/M
36-140 VDC	+/- 15 VDC	+/- 0,65 A	MGDBI-20-Q-F	/M
36-140 VDC	3,3 & +/- 12 VDC	2 A & +/- 0,4 A	MGDTI-20-Q-BE	/M
36-140 VDC	3,3 & +/- 15 VDC	2 A & +/- 0,3 A	MGDTI-20-Q-BF	/M
36-140 VDC	5 & +/- 12 VDC	2 A & +/- 0,4 A	MGDTI-20-Q-CE	/M
36-140 VDC	5 & +/- 15 VDC	2 A & +/- 0,3 A	MGDTI-20-Q-CF	/M

5

Converter Selection Chart

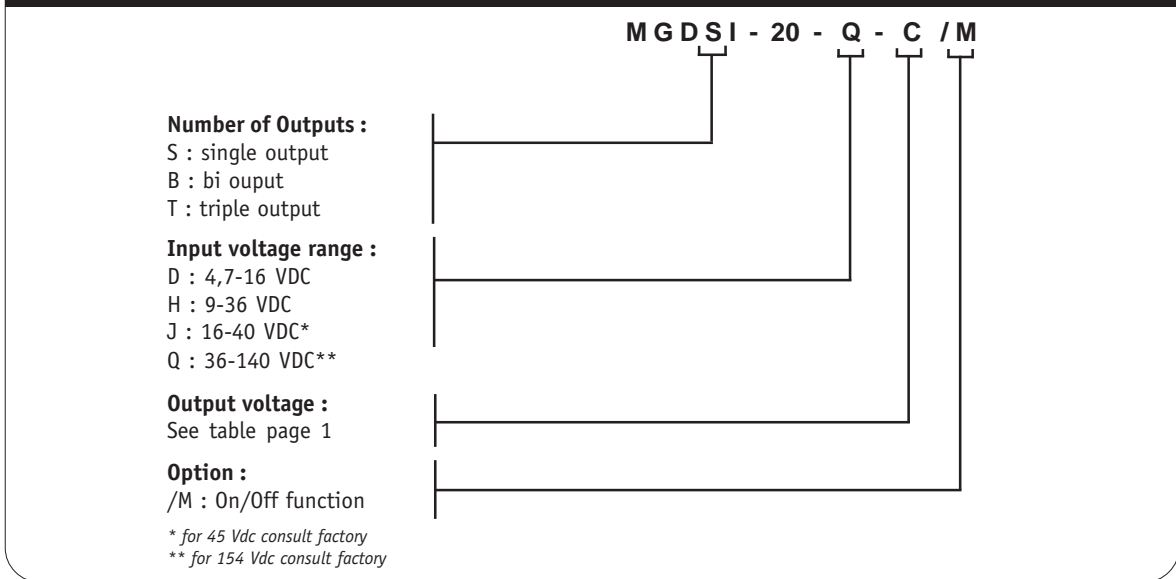

3- Electrical Specifications

Data are valid at +25°C, unless otherwise specified.

Parameter	Conditions	Limit or typical	Units	Single Output MGDSI-20			
				20-D	20 - H	20 - J	20 - Q
Input							
Nominal input voltage	Full temperature range	Nominal	VDC	9	20	24	72
Permanent input voltage range (Ui)	Full temperature range	Min. - Max.	VDC	4,7-16	9-36	16-40	36-140
Extended permanent input voltage range	Full temperature range (Consult factory)	Min. - Max.	VDC	/	/	16-45	36-154
Transient input voltage	Full load	Maximum	VDC/S	/	40/0,1	45/0,1	175/0,1
		Maximum	VDC/S	/	/	/	165/1
Start up input voltage	No undervoltage lock-out	Minimum	VDC	/	/	/	33
Undervoltage lock-out	turn-on/turn-off threshold	Min. - Max.	VDC	4-4,5	7-8,5	12-15	/
Start up time	Ui nominal Nominal output Full load : resistive	Maximum	ms	50	50	50	50
Reflected ripple current	Ui nominal, full load at switching freq. BW = 20MHz	Typical	mApp	50	50	50	50
Input current in short circuit mode (Average)	Ui nominal Short-circuit	Maximum	mA	100	60	60	40
No load input current	Ui nominal No load	Maximum	mA	100	60	60	40
Output							
Output voltage *	Full temperature range	Nominal	VDC	3,3	3,3	3,3	3,3
	Ui min. to max.	Nominal	VDC	5	5	5	5
	75% load	Nominal	VDC	12	12	12	12
		Nominal	VDC	15	15	15	15
Set Point accuracy	Ambient temperature : +25°C Ui nominal, 75% load	Maximum	%	+/- 2	+/- 2	+/- 2	+/- 2
Output power	Full temperature range Ui min. to max.	Maximum	W	20	20	20	20
Output current **		Maximum	A	4	4	4	4
3,3V output	Full temperature range Ui min. to max.	Maximum	A	4	4	4	4
5V output		Maximum	A	1,6	1,6	1,6	1,6
12V output		Maximum	A	1,3	1,3	1,3	1,3
15V output		Maximum	A	1,3	1,3	1,3	1,3
Ripple output voltage ***	Ui nominal	Maximum	mVpp	50	50	50	50
	3,3V and 5V output	Maximum	mVpp	100	100	100	100
	12V output	Maximum	mVpp	150	150	150	150
	15V output	Maximum	mVpp	150	150	150	150
Line regulation	Ui min. to max. Full load	Typical	%	+/- 1,5	+/- 1,5	+/- 1,5	+/- 1,5
Load regulation ****	Ui nominal 25% to full load	Typical	%	+/- 2,5	+/- 2,5	+/- 2,5	+/- 2,5
Efficiency	Ui nominal Full load	Typical	%	81	82	82	83
Maximum admissible Capacitive load	Ui nominal	Maximum	µF	2.000	2.000	2.000	2.000
	3,3V and 5V output						
12V and 15V output	Full load Per output	Maximum	µF	680	680	680	680

Note * : For proper operation the MGDI-20 module requires to install a 22µF chemical or tantalum capacitance across output terminals.

Note** : For 9-36V input range, the current is derated at 80% at 9V and increases linearly to full current at 12V.

Note***: The ripple output voltage is the periodic AC component imposed on the output voltage, an aperiodic and random component (noise) has also to be considered. This noise can be reduced by adding an external capacitor (typically 10nF/rated voltage depending on isolation requirement) connected between the pin Gin and the pin Gout of the converter. This capacitor should be layed-out as close as possible from the converter.

Note **** : For load regulation characteristics from 0% to full load, please contact factory.

3- Electrical Specifications (continued)

Data are valid at +25°C, unless otherwise specified.

Parameter	Conditions	Limit or typical	Units	Bi Output MGDBI-20		
				20 - H	20 - J	20 - Q
Input						
Nominal input voltage	Full temperature range	Nominal	VDC	20	24	72
Permanent input voltage range (Ui)	Full temperature range	Min. - Max.	VDC	9-36	16-40	36-140
Extended permanent input voltage range	Full temperature range (Consult factory)	Min. - Max.	VDC	/	16-45	36-154
Transient input voltage	Full load	Maximum	VDC/S	40/0,1	45/0,1	175/0,1
		Maximum	VDC/S	/	/	165/1
Start up input voltage	No undervoltage lock-out	Minimum	VDC	/	/	33
Undervoltage lock-out	turn-on/turn-off threshold	Min. - Max.	VDC	7-8,5	12-15	/
Start up time	Ui nominal	Maximum	ms	50	50	50
	Nominal output Full load : resistive					
Reflected ripple current	Ui nominal, full load at switching freq. BW = 20MHz	Typical	mApp	50	50	50
Input current in short circuit mode (Average)	Ui nominal Short-circuit	Maximum	mA	60	60	40
No load input current	Ui nominal No load	Maximum	mA	60	60	40
Output						
Output voltage *	Full temperature range	Nominal	VDC	+/- 5	+/- 5	+/- 5
	Ui min. to max.	Nominal	VDC	+/- 12	+/- 12	+/- 12
	75% load	Nominal	VDC	+/- 15	+/- 15	+/- 15
Set Point accuracy	Ambient temperature : +25°C Ui nominal, 75% load	Maximum	%	+/- 2	+/- 2	+/- 2
Output power	Full temperature range Ui min. to max.	Maximum	W	+/- 10	+/- 10	+/- 10
Output current **	Full temperature range Ui min. to max.	Maximum	A	+/- 2	+/- 2	+/- 2
		Maximum	A	+/- 0,80	+/- 0,80	+/- 0,80
		Maximum	A	+/- 0,65	+/- 0,65	+/- 0,65
		Maximum	A	+/- 0,65	+/- 0,65	+/- 0,65
Ripple output voltage ***	Ui nominal	Maximum	mVpp	50	50	50
	5V output	Maximum	mVpp	100	100	100
	12V output	Maximum	mVpp	150	150	150
	15V output	Maximum	mVpp	150	150	150
Line regulation	Ui min. to max. Full load	Typical	%	+/- 1,5	+/- 1,5	+/- 1,5
Load regulation ****	Ui nominal 25% to full load	Typical	%	+/- 2,5	+/- 2,5	+/- 2,5
Cross load output regulation	Ui nominal + Vout nominal load - Vout from 25% to full load	Typical	%	+/- 0,5	+/- 0,5	+/- 0,5
Efficiency	Ui nominal Full load	Typical	%	82	82	83
Maximum admissible Capacitive load	Ui nominal	Maximum	µF	1.000	1.000	1.000
	5V output					
	12V and 15V output					

Note * : For proper operation the MGDI-20 module requires to install a 22µF chemical or tantalum capacitance across output terminals.

Note** : For 9-36V input range, the current is derated at 80% at 9V and increases linearly to full current at 12V.

Note***: The ripple output voltage is the periodic AC component imposed on the output voltage, an aperiodic and random component (noise) has also to be considered. This noise can be reduced by adding an external capacitor (typically 10nF/rated voltage depending on isolation requirement) connected between the pin Gin and the pin Gout of the converter. This capacitor should be layed-out as close as possible from the converter.

Note **** : For load regulation characteristics from 0% to full load, please contact factory.

3- Electrical Specifications (continued)

Data are valid at +25°C, unless otherwise specified.

Parameter	Conditions	Limit or typical	Units	Tri Output MGDI-20			
				20 - H	20 - J	20 - Q	
Input							
Nominal input voltage	Full temperature range	Nominal	VDC	20	24	72	
Permanent input voltage range (Ui)	Full temperature range	Min. - Max.	VDC	9-36	16-40	36-140	
Extended permanent input voltage range	Full temperature range (Consult factory)	Min. - Max.	VDC VDC/-	/	16-45	36-154	
Transient input voltage	Full load	Maximum	S	40/0,1	45/0,1	175/0,1	
		Maximum	VDC/-	/	/	165/1	
Start up input voltage	No undervoltage lock-out	Minimum	VDC	/	/	33	
Undervoltage lock-out	turn-on/turn-off threshold	Min. - Max.	VDC	7-8,5	12-15	/	
Start up time	Ui nominal Nominal output Full load : resistive	Maximum	ms	50	50	50	
Reflected ripple current	Ui nominal, full load at switching freq. BW = 20MHz	Typical	mApp	50	50	50	
Input current in short circuit mode (Average)	Ui nominal Short-circuit	Maximum	mA	60	60	40	
No load input current	Ui nominal No load	Maximum	mA	60	60	40	
Output							
Output voltage *	Full temperature range Ui min. to max. 75% load	Nominal	VDC	3,3 & +/- 12	3,3 & +/- 12	3,3 & +/- 12	
		Nominal	VDC	3,3 & +/- 15	3,3 & +/- 15	3,3 & +/- 15	
		Nominal	VDC	5 & +/- 12	5 & +/- 12	5 & +/- 12	
		Nominal	VDC	5 & +/- 15	5 & +/- 15	5 & +/- 15	
Set Point accuracy	Ambient temperature : +25°C Ui nominal, 75% load	Maximum	%	+/- 2	+/- 2	+/- 2	
Output power	Full temperature range Ui min. to max.	Maximum	W	10 & +/- 5	10 & +/- 5	10 & +/- 5	
Output current **	Full temperature range Ui min. to max.	3,3V & +/- 12V output	Maximum	A	2 & +/- 0,4	2 & +/- 0,4	2 & +/- 0,4
		3,3V & +/- 15V output	Maximum	A	2 & +/- 0,3	2 & +/- 0,3	2 & +/- 0,3
		5V & +/- 12V output	Maximum	A	2 & +/- 0,4	2 & +/- 0,4	2 & +/- 0,4
		5V & +/- 15V output	Maximum	A	2 & +/- 0,3	2 & +/- 0,3	2 & +/- 0,3
		5V & +/- 15V output	Maximum	A	2 & +/- 0,3	2 & +/- 0,3	2 & +/- 0,3
Ripple output voltage ***	Ui nominal Full load BW = 20MHz	3,3V and 5V output	Maximum	mVpp	50	50	50
		12V output	Maximum	mVpp	100	100	100
		15V output	Maximum	mVpp	150	150	150
		15V output	Maximum	mVpp	150	150	150
Line regulation	Ui min. to max. Full load	Typical	%	+/- 1,5	+/- 1,5	+/- 1,5	
Load regulation	Ui nominal 25% to full load	Typical	%	+/- 2,5	+/- 2,5	+/- 2,5	
Cross load output regulation	Ui nominal + Vout nominal load - Vout from 25% to full load	Typical	%	+/- 0,5	+/- 0,5	+/- 0,5	
Efficiency	Ui nominal Full load	Typical	%	82	82	83	
Maximum admissible Capacitive load	Ui nominal Full load Per output	3,3V and 5V output	Maximum	μF	1 000	1 000	1 000
		12V and 15V output	Maximum	μF	100	100	100
		12V and 15V output	Maximum	μF	100	100	100

Note * : For proper operation the MGDI-20 module requires to install a 22μF chemical or tantalum capacitance across output terminals.

Note** : For 9-36V input range, the current is derated at 80% at 9V and increases linearly to full current at 12V.

Note***: The ripple output voltage is the periodic AC component imposed on the output voltage, an aperiodic and random component (noise) has also to be considered. This noise can be reduced by adding an external capacitor (typically 10nF/rated voltage depending on isolation requirement) connected between the pin Gin and the pin Gout of the converter. This capacitor should be layed-out as close as possible from the converter.

4- Switching Frequency

Parameter	Conditions	Limit or typical	Specifications
Switching frequency	Full temperature range Ui min. to max. No load to full load	Nominal, fixed	4.7-16 VDC input : 480 KHz 9-36 VDC input : 480 KHz 16-40 VDC input : 480 KHz 36-140 VDC input : 430 KHz

5- Isolation

Parameter	Conditions	Limit or typical	Specifications
Electric strength test voltage (basic version)	Input to output	Minimum	1 500 VDC / 1 min
Electric strength test voltage between outputs (for dual and triple outputs)	Output to output	Minimum	No isolation
Isolation resistance	500 VDC	Minimum	100 MOhm

6- Protection Functions

Characteristics	Protection Device	Recovery	Limit or typical	Specifications
Input undervoltage lock-out (UVLO)	Turn-on, turn-off circuit with no hysteresis	Automatic recovery	Threshold	See section 3
Output short circuit protection (SCP)	Hiccup circuitry with auto-recovery	Automatic recovery	Permanent	See section 12
Output overvoltage protection (OVP)	Zener clamp	/	Maximum Maximum Maximum	For 3.3v : 4v For 5v : 6v For 12v : 14v For 15v : 17v

7- Reliability Data

Characteristics	Conditions	Temperature	Specifications
Mean Time Between Failure (MTBF) According to MIL-HDBK-217F	Ground fixed (Gf)	Case at 40°C Case at 70°C	750 000 Hrs 320 000 Hrs
	Ground mobile (Gm)	Case at 40°C Case at 70°C	208 000 Hrs 85 000 Hrs
Mean Time Between Failure (MTBF) According to IEC-62380-TR	Railway, Payphone	Ambient at 25°C 100% time on	240 000 Hrs

8- Electromagnetic Interference

Electromagnetic interference requirements according to EN55022 class A and class B can be easily achieved as indicated in the following table :

Electromagnetic Interference according to EN55022			
Conducted noise emission	Configuration	With common mode capacitor $C_c = 10\text{nF}$ and input capacitor C_i	With common mode capacitor $C_c = 10\text{nF}$ and external filter
	Models		
Conducted noise emission	4,7-16V input models	Class A, $C_i = 10\mu\text{F}/35\text{V}$ tantalum + inductance 4,7mH	Class B
	9-36V input models	Class A, $C_i = 4,7\mu\text{F}/50\text{V}$ tantalum	Class B
	16-40V input models	Class A, $C_i = 4,7\mu\text{F}/50\text{V}$ tantalum	Class B
	36-140V input models	Class A, $C_i = 47\mu\text{F}/200\text{V}$ chemical	/
Radiated noise emission	Configuration	With common mode capacitor $C_c = 10\text{nF}$	
	Models	Class B	
	All models		

8-1 Module Compliance with EN55022 class A Standard

Electromagnetic interference requirements according to EN55022 class A can be easily achieved by adding an external common mode noise capacitance ($C_c = 10\text{nF}/\text{rated voltage}$ depending on isolation

requirement) and an input capacitance (C_i Value explained in previous table). This common mode noise capacitance C_c should be layed-out as close as possible from the DC/DC converter.

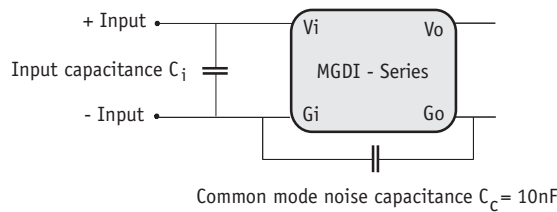

8-2 module Compliance with EN 55022 Class B Standard

Electromagnetic interference requirements according to EN55022 class B can be easily achieved by adding an external input filter consisting of 4 capacitances, a common mode choke, a differential mode inductance

and the common mode noise capacitance ($C_c = 10\text{nF}/\text{rated voltage}$ depending on isolation requirement). Please consult EN55022 Class B EMI Filter design note for further details.

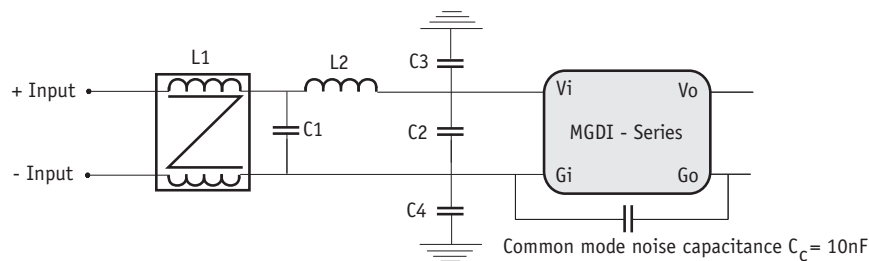

* Note : Value of common mode noise capacitance depends on isolation requirements (typically 10nF/1500V or 10nF/3000V). In case of dielectric strength test in AC mode, adapt the capacitance value in order to be compatible with maximum admissible leakage current.

9- Surge Susceptibility EN61000-4-5 & EN50155

Surge susceptibility requirements according to EN50155, EN61000-4-5 and electromagnetic interference requirements of EN55022 class A can easily be achieved using either :

- a limiter module LGDS-50 series : ready-to-use single module solution,
- an input limiter filter : schematics of discrete components, to sustain the following surge levels :

Characteristics	Standards	Levels
Spikes Line to line	EN 61000-4-5	Level 4 with 4 000 V waveform 50 μ s, impedance 2 Ohm
	EN 50155	Level 1 800 V waveform 50 μ s, impedance 100 and 5 Ohm Level 8 400 V waveform 0.1 μ s, impedance 100 Ohm
Spikes Line to earth	EN 61000-4-5	Level 4 with 4 000 V waveform 50 μ s, impedance 12 Ohm
	EN 50155	Level 1 800 V waveform 50 μ s, impedance 100 and 5 Ohm Level 8 400 V waveform 0.1 μ s, impedance 100 Ohm

9-1 Surge Protection with Off-the-Shelf Solution : LGDS-50 Limitor Module

To sustain surge requirements of EN61000-4-5, and EN50155 together with EN55022 class A, GAIA Converter proposes a ready-to-use single product. Depending on bus input range two references of limiter module are existing with references as follow :

Input types	DC/DC converter family	Limiter module reference
9-36 VDC Input	MGDI-20-H series	LGDS-50-J-K
16-40 VDC Input	MGDI-20-J series	LGDS-50-J-K
36-140 VDC Input	MGDI-20-Q series	LGDS-50-Q-K

These modules designated LGDS-50 series are designed up to 50W power and will protect MGDI-20 series with 9-36, 16-40 or 36-140 VDC input against surges.

The implantation of LGDS-50 with modules can be undertook as follow :

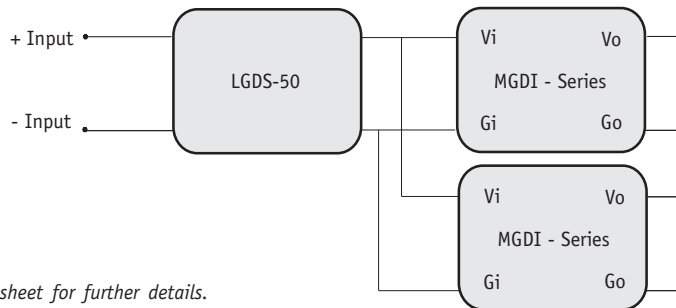

Please consult LGDS-50 datasheet for further details.

9-2 Surge Protection with Discrete Components

To sustain surge requirements of EN61000-4-5 and EN50155 together with EN55022 class A, GAIA Converter proposes the following front protection filter.

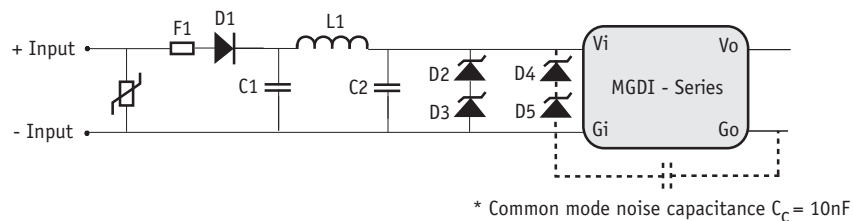

Please consult EN50155 Transient/EMI filter design note for further details.

* Note : Value of common mode noise capacitance rated voltage depends on isolation requirements.

10- Thermal Characteristics

Characteristics	Conditions	Limit or typical	Performances
Operating ambient temperature range at full load	Ambient temperature *	Minimum Maximum	- 40°C + 71°C
Operating case temperature range at full load	Case temperature	Minimum Maximum	- 40°C +95°C
Storage temperature range	Non functioning	Minimum Maximum	- 40°C + 105°C
Thermal resistance	Rth case to ambient in free air natural convection	Typical	7°C /W

Note * : The upper temperature range depends on configuration, the user must assure a max. case temperature of + 95°C.

The MGDI-20 series operating **case** temperature must not exceed 95°C. The maximum **ambient** temperature admissible for the DC/DC converter corresponding to the maximum operating case temperature of 95°C depends on the ambient airflow, the mounting/orientation, the cooling features and the power dissipated.

To calculate a maximum admissible ambient temperature the following method can be used. Knowing the maximum case temperature Tcase = 95°C of the module, the power used Pout and the efficiency η :

- determine the power dissipated by the module P_{diss} that should be evacuated :

$$P_{diss} = P_{out}(1/\eta - 1)$$

- determine the maximum ambient temperature :

$$T_a = 95^\circ\text{C} - R_{th} \times P_{diss}$$

where **Rth** is the thermal resistance from the case to ambient.

The previous thermal calculation shows two areas of operation :

- a normal operation area in a free natural ambient convection (grey area in this following graph),
- an area with cooling features (air flow or heatsink) ensuring a maximum case temperature below the maximum operating case temperature of 95°C (white area in the following graph).

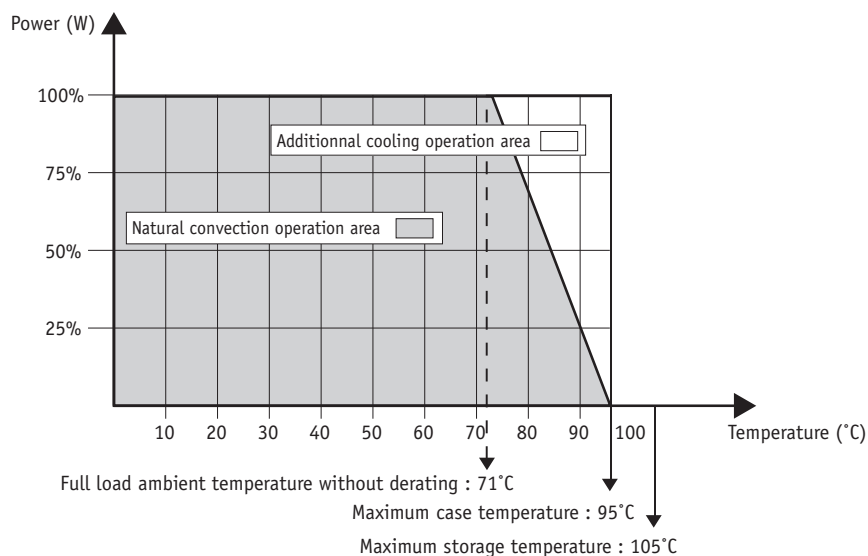

11- Environmental Qualifications

The modules have been subjected to the following environmental qualifications.

Characteristics	Conditions	Severity	Test procedure
Climatic Qualifications			
Life at high temperature	Duration Temperature Status of unit	1 000 Hrs 95°C case unit operating	IEC 68-2-2
Humidity steady	Damp heat Temperature Duration Status of unit	93 % relative humidity 40°C 56 days unit not operating	IEC 68-2-3 Test Ca
Temperature cycling	Number of cycles Temperature change Transfert time Steady state time Status of unit	200 -40°C / +71°C 40 min. 20 min. unit not operating	IEC 68-2-14 Test N
Temperature shock	Number of shocks Temperature change Transfert time Steady state time Status of unit	50 -40°C / +105°C 10 sec. 20 min. unit not operating	IEC 68-2-14 Test Na
Mechanical Qualifications			
Vibration (Sinusoidal)	Number of cycles Frequency : amplitude Frequency : acceleration Amplitude /acceleration Duration Status of unit	10 cycles in each axis 10 to 60 Hz / 0.7 mm 60 to 2000 Hz / 10 g 0.7 mm/10 g 2h 30 min. per axis unit not operating	IEC 68-2-6 Test Fc
Shock (Half sinus)	Number of shocks Peak acceleration Duration Shock form Status of unit	3 shocks in each axis 100 g 6 ms 1/2 sinusoidal unit not operating	IEC 68-2-27 Test Ea
Bump (Half sinus)	Number of bumps Peak acceleration Duration Status of unit	2 000 bumps in each axis 25 g 6 ms unit not operating	IEC 68-2-29 Test Eb
Electrical Immunity Qualifications			
Electrical discharge susceptibility	Number of discharges Air discharge level Contact discharge level Air discharge level Contact discharge level	10 positive & 10 negative discharges 4 kV : sanction A 2 Kk : sanction A 8 Kk : sanction B 4 kV : sanction B	EN55082-2 with : EN61000-4-2 IEC 801-2
Electrical field susceptibility	Antenna position Electromagnetic field Wave form signal Frequency range	at 1 m 10 V/m AM 80%, 1 kHz 26 MHz to 1 GHz	EN55082-2 with : EN61000-4-3 IEC801-3
Electrical fast transient susceptibility	Burst form Wave form signal Impedance Level 1 Level 3	5/50 ns 5 kHz with 15 ms burst duration period 300 ms 50 Ohm 0,5 kV : sanction A 2 kV : sanction B	EN55082-2 with : EN61000-4-4 IEC801-4
Surge Susceptibility	Surge form Impedance Level 4	1,2/50 µs 2 Ohm 4 kV : with transient protection or LGDS-50 limiter module (see section surge)	EN61000-4-5 EN50155

12- Description of Protections

12-1 Input Undervoltage Lock-out (UVLO)

The input undervoltage lock-out protection device turns-on and turns-off the output voltage when the input bus voltage reaches the undervoltage lock-out threshold. There is no hysteresis cycle at turn-on and turn-off. For «Q» input range models, the UVLO protection is not implemented.

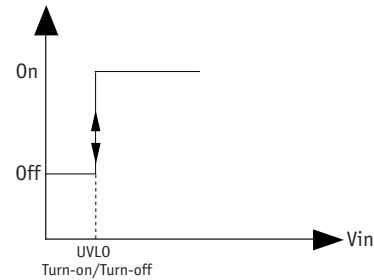

12-2 Output Short Circuit Protection (SCP)

The short circuit protection device protects the module against short circuit of any duration and restores the module to normal operation when the short circuit is removed. It operates in «hiccup» mode by testing periodically if an overload is applied (typically every 200ms recovery time). The overload detection threshold is typically 200% of maximum current with a detection time lower than 5ms.

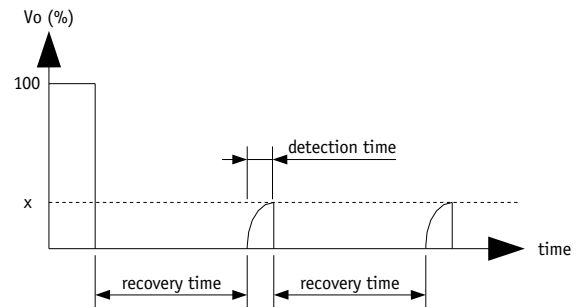

12-3 Output Overvoltage Protection (OVP)

The output overvoltage protection device protects external components against high voltage or possible overvoltages which can be supplied by the module (i.e in case of internal failure). It consists of a zener diode clamping the output voltage; under worst case conditions this zener diode will short-circuit. The output voltage protection is not designed to withstand externally applied output overvoltages to protect the module itself.

13- Description of Functions

13-1 Option (/M) : On/Off Function

The optionnal control pin 4 (On/Off) can be used for applications requiring On/Off operation. By using an open collector command with a transistor Q referenced to the common terminal (Gi) :

- A logic pulled low (<math><0.2V@1mA</math>, referenced to Gi) on pin 4 disables the converter
- No connection or high impedance on pin 4 enables the converter.

By releasing the On/Off function, the converter will restart within the start-up time specifications given in table page 3. For further details please consult "Logic On/Off" application note.

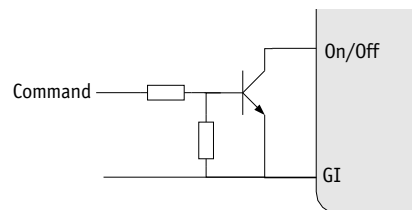

14- Application Notes

14-1 Connection of Outputs in Series

Any of the bi output converters can be configured to produce an output of 10V (+/-5 output models), 24V (+/-12V output models), or 30V (+/-15V output models) by connecting the load across the output (+) and the output (-) with either output grounded, and leaving the common pin floating.

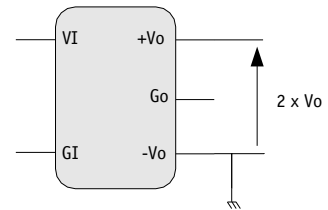

14-2 Connection of Modules in Series

The output of single output units can be connected in series without any precautions to provide higher output voltage level.

Nevertheless, GAIA Converter recommends to protect each individual output by a low power shottky diode rated with the maximum current of the converter to avoid reverse polarity at any output.

Reverse polarity may occur at start up if the output voltages do not rise at the same time.

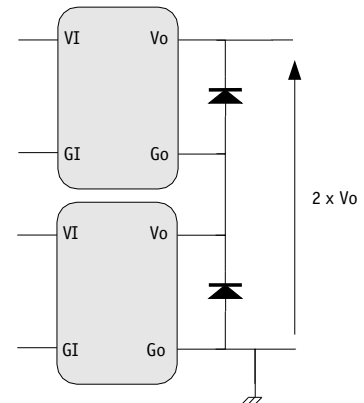

14-3 Connection of Modules in Parallel

Several converters with equal output voltage can be connected in parallel to increase power. Nevertheless some cares have to be taken in particular as the output voltage of each converter is slightly different, when paralleling, the converter with the highest output voltage will source the most current.

However the GAIA Converter modules are designed with a "soft" output voltage versus current characteristic. This causes the output voltage of each converter to automatically adjust downward as its current increases so each converter very approximately shares the total output current. It is important that each converter has approximately the same impedance between their output and the common load.

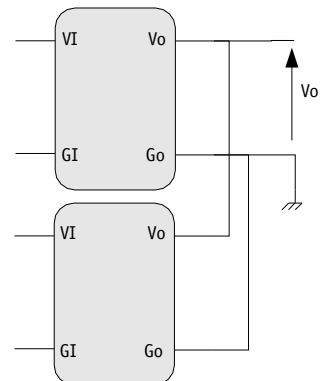

14-4 Safety Consideration

For safety agency approval of the system in which the power module is used, the power module must be installed in compliance with requirements of the UL1950, CSA22.2-950, EN60950 standards : i.e if the output circuit operator accessible, it shall be a SELV circuit.

A SELV (Safety Extra Low Voltage) output for a converter is a secondary circuit that under normal operation or a single fault condition cannot reach hazardous voltage (i.e Voltage above 60 VDC) between any two accessible parts or an accessible part and protective each.

In the event of a single fault condition (insulation or component failure), the voltage in accessible parts of SELV

circuits shall not exceed 60 VDC for longer than 0.2 sec. and an absolute limit of 120 VDC SELV circuits must be separated from hazardous voltages (e.g primary circuits) by two levels of protection which may be double or reinforced insulation or basic insulation combined with an earthed conductive barrier.

Generally DC/DC Converters are power by an input bus that comes from a front end which can be an AC/DC powered supply, a transformer, a charger or a battery. It is the sole responsibility of the user to ensure compliance of the front-end with the relevant safety requirements.

The following table resumes some possible installation configuration using Gaia Converter wide input series.

Bus voltage at the input of DC/DC converter	Safety status of the input bus	DC/DC converter requirements	Resulting safety at the DC/DC converter output
Voltage : ≤ 60 VDC	Basic isolation with ELV circuit Basic isolation with earthed SELV circuit	Operational insulation Operational insulation	Earthed SELV circuit SELV circuit
Hazardous voltage : > 60 VDC	Basic isolation with hazardous voltage Double or reinforced insulation with hazardous voltage	Operational insulation Operational insulation	Earthed SELV circuit Earthed SELV circuit

15- Dimensions

Dimension are given in mm (inches). Tolerance : +/- 0,2 mm (+/- 0.01 ") unless otherwise indicated.
Weight : 80 grams (2.8 Ozs) max.

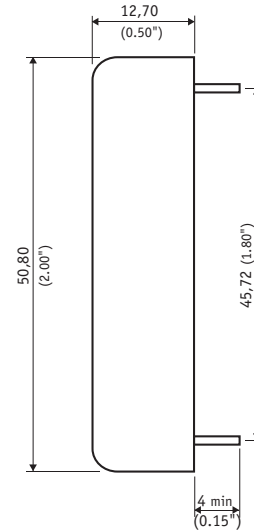
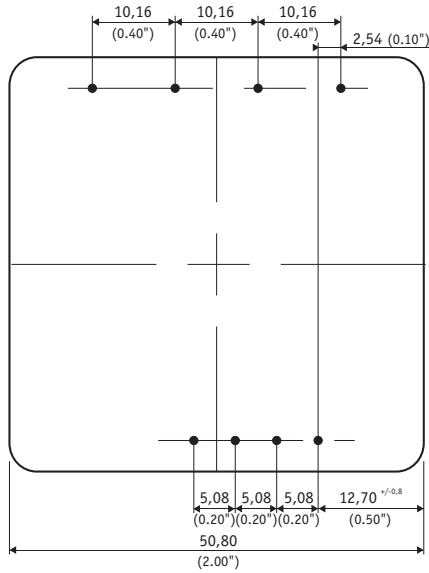

Pin dimensions : Ø 0,83 mm (0.033 ")

16- Materials

Case : Matallic black anodized coating.
Pins : Plated with pure matte tin over nickel underplate.

17- Product Marking

Upper face : Company logo, location of manufacturing.
Side face : Module reference, option, date code : year and week of manufacturing.

18- Connections

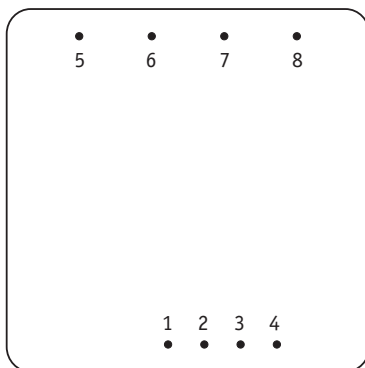

Bottom view

Pin	Single	Bi	Triple
1	+ Input (Vi)	+ Input (Vi)	+ Input (Vi)
2	- Input (Gi)	- Input (Gi)	- Input (Gi)
3	Case	Case	Case
4	Non connected*	Non connected*	Non connected*
5	Do not connect	Output + (+Vo)	Output 2+ (+V2)
6	Output (Vo)	Common (Go)	Output 1 (V1)
7	Common (Go)	Output - (-Vo)	Common (Go)
8	Do not connect	Do not connect	Output 2- (-V2)

* Option /M : Pin 4 connected for On/Off function.
Please add /M to module reference.



For more detailed specifications and applications information, contact :

International Headquarters

GAIA Converter - France
ZI de la Morandière
33185 LE HAILLAN - FRANCE
Tel. : + (33)-5-57-92-12-80
Fax : + (33)-5-57-92-12-89

North American Headquarters

GAIA Converter Canada, Inc
4038 Le Corbusier Blvd
LAVAL, QUEBEC - CANADA H7L 5R2
Tel. : (514)-333-3169
Fax : (514)-333-4519

Represented by :